

---

---

# use & care guide

---

---

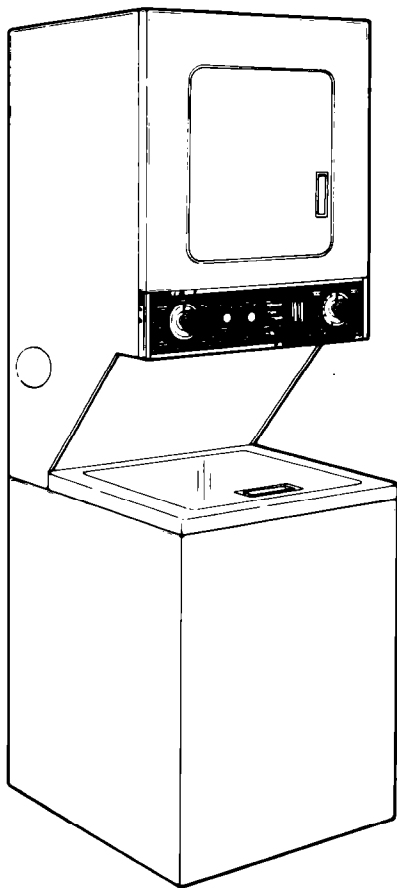

thin  
twin

**WASHER • DRYER**

**Model LT4905XM**

---

---

Wave Ovens, Trash Compactors, Room Air Conditioners, Dehumidifiers, Automatic Washers, Clothes Dryers, Freezers, Refrigerator-Freeze

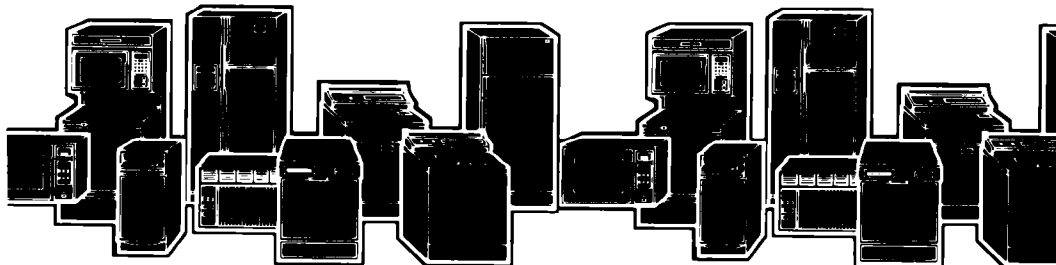

# Parts and features

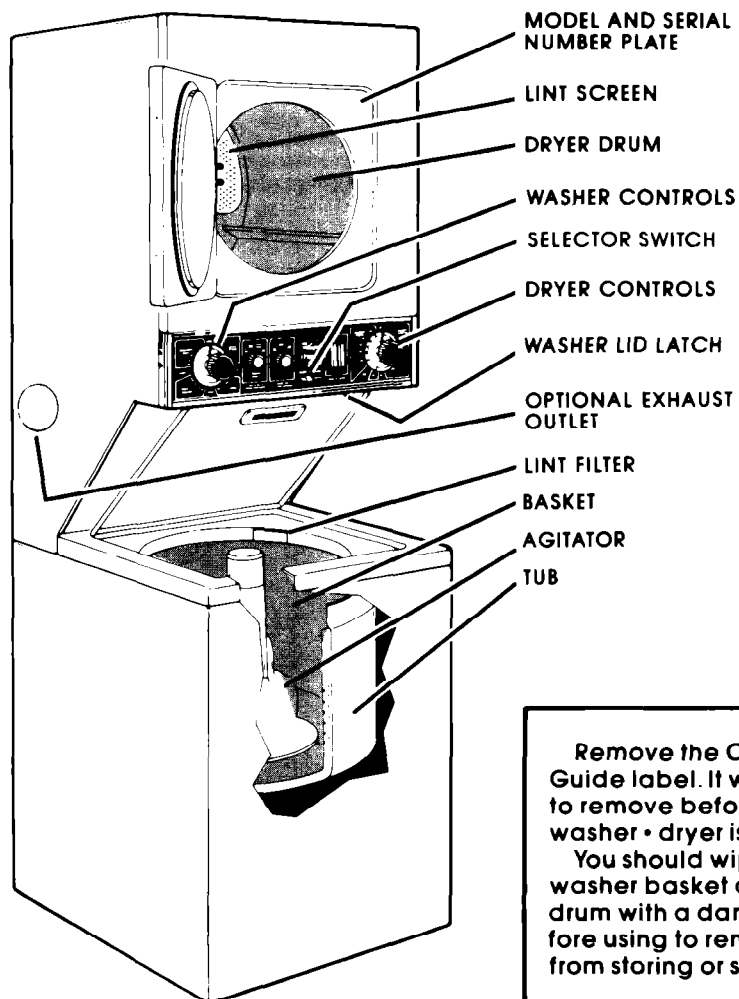

Remove the Consumer Buy Guide label. It will be easier to remove before the washer • dryer is used. You should wipe out the washer basket and dryer drum with a damp cloth before using to remove dust from storing or shipping.

## Copy your Model and Serial Numbers here

When you need service or call with a question, have this information ready:

1. **Complete** Model and Serial Numbers (from the plate located as shown).
2. Purchase date from sales slip.

Copy this information in these spaces. Keep this book, your warranty and sales slip together in a handy place. There is no warranty registration to return. Proof-of-purchase is all that is required for in-warranty service.

\_\_\_\_\_

Complete Model Number

\_\_\_\_\_

Complete Serial Number

\_\_\_\_\_

Purchase Date

\_\_\_\_\_

Service Company and Telephone Number

# Contents

	Page		Page
<b>Your Responsibilities</b> .....	3	<b>Lint Screen</b> .....	14
Safety .....	4	<b>Lint Removal</b> .....	14
<b>Before Using Your Washer • Dryer</b> .....	5	<b>WASHER • DRYER</b>	
<b>WASHER</b>		<b>Caring for Your Washer • Dryer</b> .....	15
<b>Starting Your Washer</b> .....	6	Cleaning Dryer Interior ...	15
<b>What Happens in Each Cycle</b> .....	8	Vacation Care .....	16
<b>Other Operating Instructions</b> .....	10	Winterizing .....	16
Cleaning the Lint Filter ....	10	<b>If You Need Service or Assistance</b> .....	17
<b>DRYER</b>		1. Before Calling for Assistance .....	17
<b>Starting Your Dryer</b> .....	11	2. If You Need Assistance ..	18
<b>Selecting a Cycle</b> .....	12	3. If You Need Service ....	18
<b>Drying Tips</b> .....	13	4. If You Have a Problem ..	18

©1985 Whirlpool Corporation

## Your responsibilities

Read this "Use and Care Guide" and your "Laundry Guide" carefully for important use and safety information.

**You are personally responsible for installation.** Have your washer / dryer installed by a qualified installer and make sure that it has been ...

1. Installed exactly according to the "Installation Instructions," including ...
  - proper electrical supply, outlet and grounding;\*
    - proper water supply, plumbing fixtures and drain;\*
    - proper dryer exhausting system.\*
2. Installed and leveled in a room where ...
  - there is adequate ventilation and protection from weather;
  - the floor is strong enough to support the weight;
  - The temperature is above 45° F (7.2° C) because ...
    - the dryer will not operate properly at cold temperatures.
    - freezing temperatures can damage the washer.

\*Refer to the "Installation Instructions" for complete information.

**You are personally responsible for proper use of your washer / dryer.** You must be sure that it is ...

1. Used only by those who understand how to operate it properly.
2. Properly maintained and used only for jobs expected of home washers and dryers.

**You are personally responsible for the safe use of your washer / dryer.**

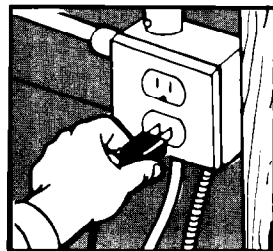

**DO NOT** try to service this appliance unless it is unplugged or the electrical power has been turned off.

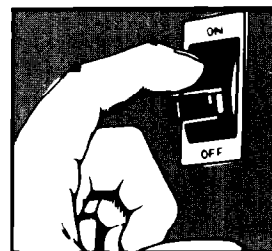

**HAZARDOUS FUMES** can be formed if chlorine bleach is used in the same wash as ammonia or acids such as vinegar or rust remover.



**• FOR YOUR SAFETY •**  
DO NOT STORE OR USE GASOLINE OR OTHER FLAMMABLE VAPORS AND LIQUIDS IN THE VICINITY OF THIS OR ANY OTHER APPLIANCE.

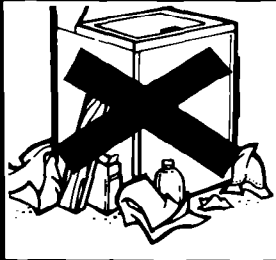

**DO NOT** let dust, lint, paper, rags, chemicals, etc., pile up around or under the appliance. **DO NOT** install the appliance against drapes or curtains.

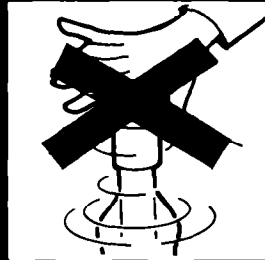

**NEVER** put your hands into the washer until all motion stops. If the lid is opened while the basket is spinning, the basket will automatically stop in a few seconds.

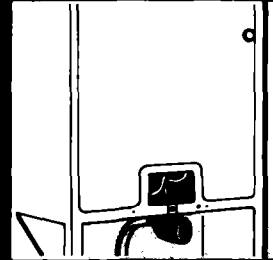

**NEVER** operate the appliance if...

- it is not working right,
- it is damaged,
- parts are missing,
- all panels are not in place.

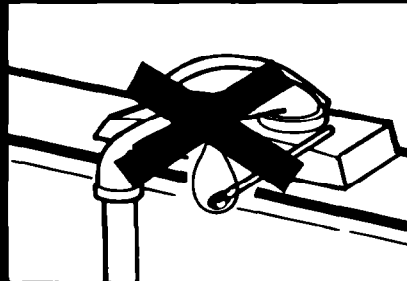

**SPECIAL CAUTION:** If hot water has not been used recently (usually two weeks or longer), flammable hydrogen gases may build up in the water heater and hot water pipes. To prevent injury or damage, turn on all hot water faucets and allow water to run for several minutes. This will allow gases to escape. Do not smoke or use any open flame near the faucet while it is open.

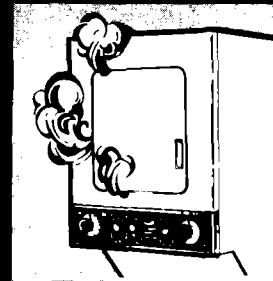

**FIRE HAZARD and DAMAGE** to some materials can result from:

- drying heat-sensitive fabrics with heat (see page 12).
- operating the dryer with the lint screen loose, damaged or missing.
- allowing lint to build up inside the dryer (see page 13).

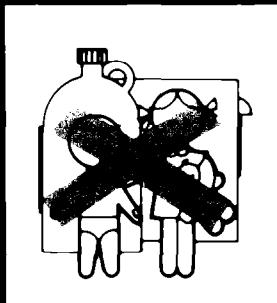

**DO NOT** allow children to operate or play with the washer.

**ALWAYS** store detergent, laundry aids and other materials in a cool, dry place where children can't reach them – in a locked cabinet, if possible.

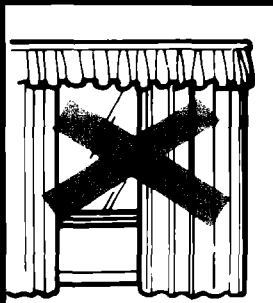

**DO NOT** machine wash or dry glass fiber materials. Small particles can stick to fabrics washed and dried in following loads and cause skin irritation.

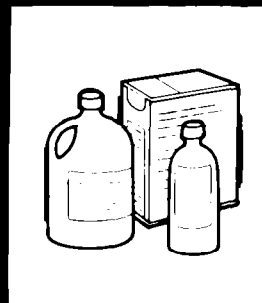

**ALWAYS** read and follow instructions on packages of detergent and laundry aids – especially warnings and precautions.

• **SAVE THESE INSTRUCTIONS** •

## Before using your THIN TWIN\* washer • dryer

For best washing and drying results, you must take some very important steps before, during and after each load:

1. Prepare and sort each load for washing ("Laundry Guide," pages 4-5).
2. Measure and add detergent or soap to washer ("Laundry Guide," pages 9-10).
3. Load the washer properly ("Laundry Guide," pages 6-7).
4. Select the water temperature, load size and cycle recommended for the fabrics before starting the washer ("Use and Care Guide," pages 6-7).
5. Add other laundry aids to the washer according to instructions ("Laundry Guide," pages 11-13).
6. Properly sort the load for drying ("Laundry Guide," pages 18-19).
7. Select the right drying cycle and time for the fabrics ("Use and Care Guide," page 12).
8. Remove and hang or fold items **immediately** after drying.

**Service or performance problems caused by the use of any product not manufactured by Whirlpool Corporation are the responsibility of the manufacturer of that product.**

# Starting your washer

Before starting your washer, be sure you have measured and added detergent, and have put in a properly sorted load as recommended in your "Laundry Guide."

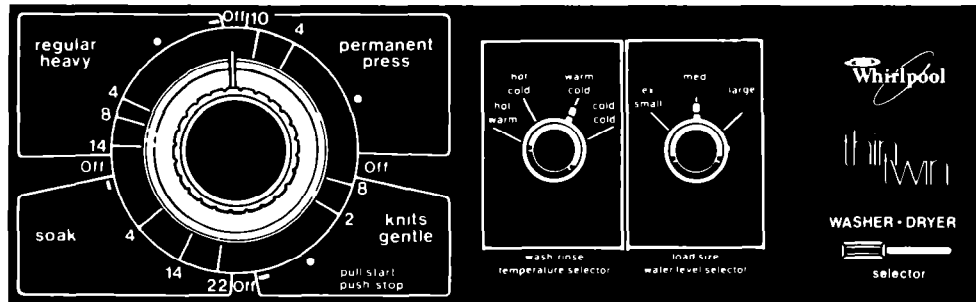

## 1. SELECTOR SWITCH

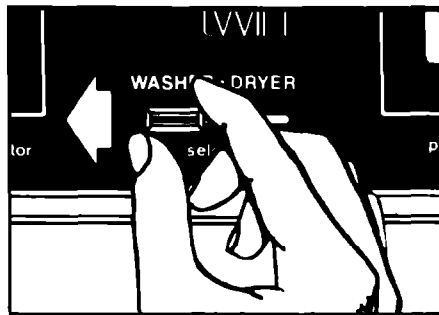

- Move Selector Switch to WASHER position. Washer will not operate when switch is in DRYER position.

## 3. TEMPERATURES

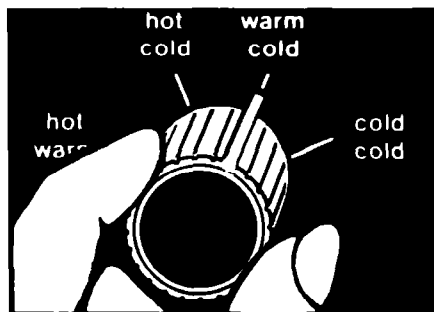

- Match the wash water temperature to the type of fabrics and soils being washed.

Recommended wash temperatures can be found in your "Laundry Guide"

6

## 2. LOAD SIZE

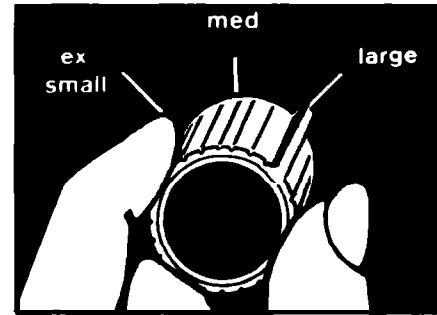

- Turn the knob to point at a setting that describes the size of load you want to wash.
- The water level can be set for EX SMALL, MEDIUM or LARGE loads. Select the water level that matches the load size.

See your "Laundry Guide" for details on load sizes.

### LOAD SIZES AND WATER LEVELS

For best cleaning results, the load must be able to move freely in the water. Too big a load or too little water can tear items.

**LARGE**  
(11.9 gals./45.1 L)\*

**MEDIUM**  
(9.6 gals./36.3 L)\*

**EX-SMALL**  
(7.3 gals./27.7 L)\*

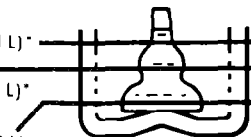

\* Approximate fill with load

To hold the washer lid up, lift the lid until it snaps past the latch.

To release the lid, push the lid latch up.

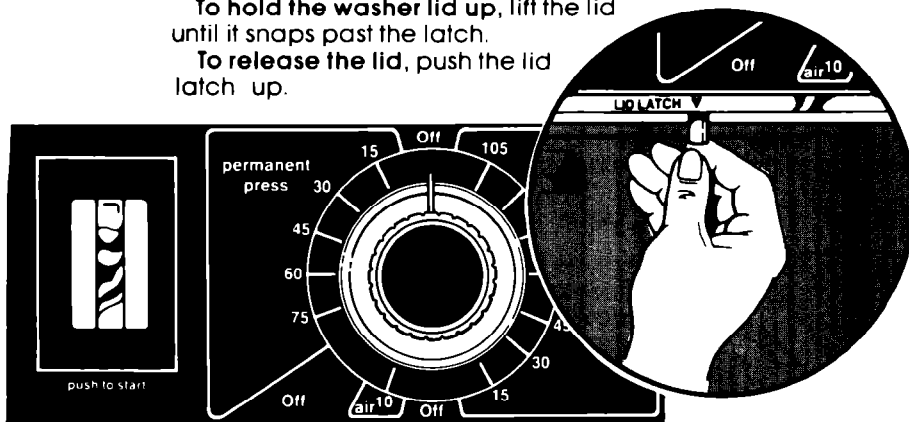

#### Select CYCLE and WASH TIME; 4. Start the washer

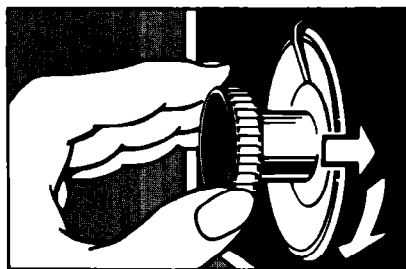

**A.** Push in the Control Knob and turn it to the right. It must be pushed in and turned only clockwise.

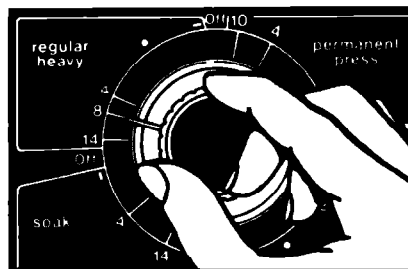

**B.** Stop on a number in the cycle you want. The numbers are minutes of wash time. The drawing shows 8 minutes of agitation in the REGULAR HEAVY Cycle.

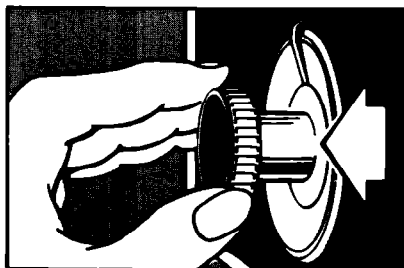

**C.** Start the washer by pulling out the Control Knob. The washer will fill to the level you set with wash water of the selected temperature. After filling, the washer will agitate for the selected number of minutes.

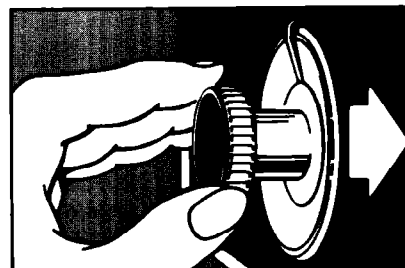

**D.** To stop the washer at any time, push in the Control Knob. To restart the washer, pull out the Control Knob.

To set the controls for a rinse and spin, a drain and spin, or a soak or pre-wash, see page 10.

# What happens in each cycle

Each cycle has different agitation and spin speeds designed for different kinds of fabrics. Numbers on the dial in each cycle are the minutes of WASH agitation time.

When the Cycle Control Knob is set to a number and pulled out, the washer fills before agitation and timing starts. After agitation starts, the knob turns

## REGULAR HEAVY Cycle

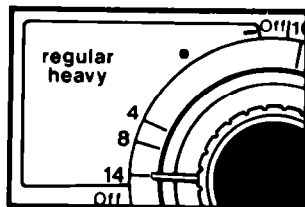

A cycle for sturdily constructed fabrics that are heavily to moderately soiled.

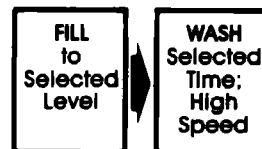

## PERMANENT PRESS Cycle

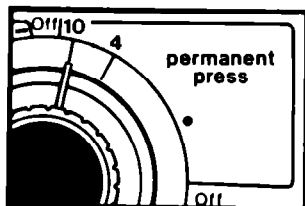

A special cycle with the necessary **cool-down** rinse which helps keep wrinkles from setting into Permanent Press and some synthetic fabrics.

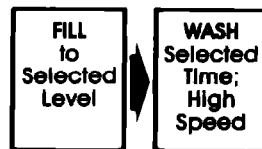

## KNITS/GENTLE Cycle

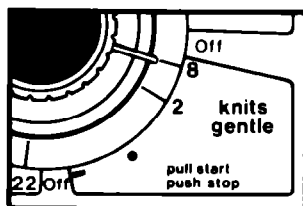

A cycle that gently washes and spins delicate items and washable knits. Wash nylon hose in a net laundry bag.

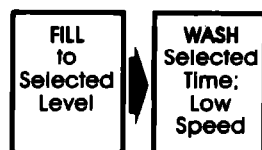

## SOAK Cycle

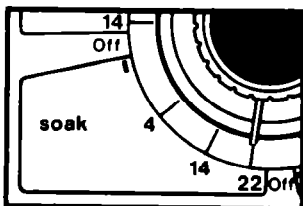

Periods of agitation and soaking time help remove heavy soils and certain stains that need extra pretreatment. Use recommended amount of detergent. **The SOAK Cycle should always be followed by a Wash Cycle.**

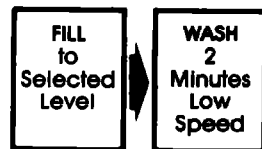



clockwise until it points to OFF and the cycle ends.

**NOTE:** You may hear the sound of water spraying during the spin parts of some cycles. In some cycles, cold water is sprayed on the spinning load to help with the rinsing.

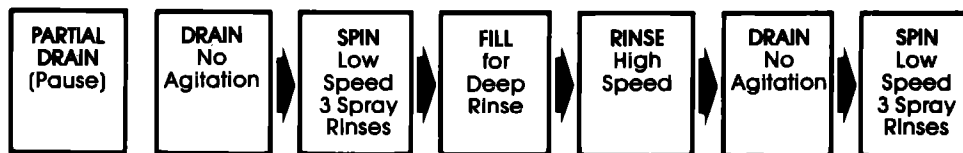
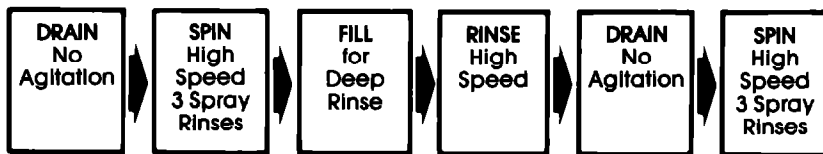

**NOTE:** Always use **cold rinse water** for permanent press fabrics.

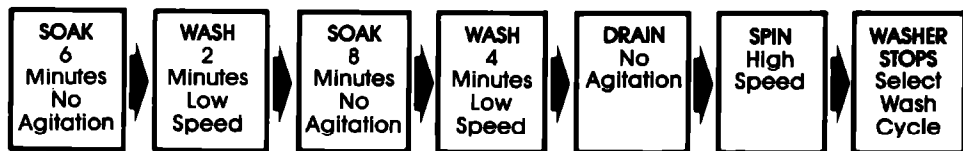
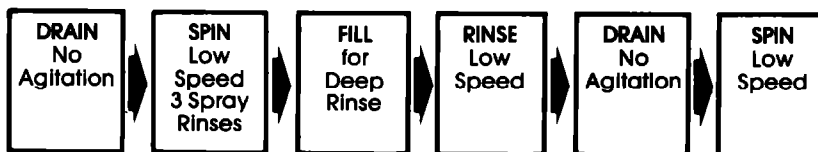

← Pre-wash setting begins here (see page 10)

Special care is needed when soaking or pre-washing laundry. See your "Laundry Guide" for proper use of this cycle.

## Other operating instructions

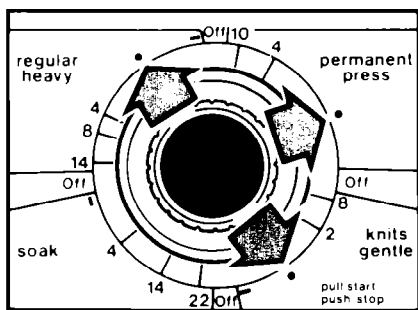

### For a rinse and spin

You may need an extra rinse and spin for heavily soiled loads which need more detergent. (Extra detergent can require an extra rinse.)

- Push Control Knob in.
- Turn clockwise to any ● on the dial. See above drawing.
- Pull Control Knob out.
- The washer will fill to selected level with cold water, agitate 2 minutes, drain and spin.

For agitation and spin speeds in each cycle, see pages 8 and 9.

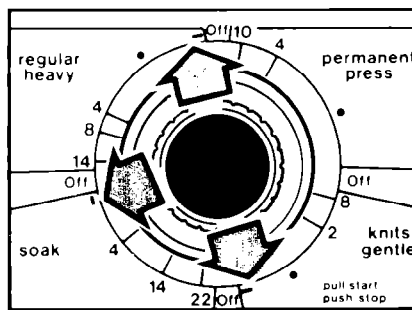

### For a drain and spin

Your washer can be set to drain and spin out water.

- Push Control Knob in.
- Turn clockwise to the bar just before OFF. See above drawing.
- Pull Control Knob out.
- The washer will drain and spin.

### For a soak or pre-wash

For best results, use warm water for soaking or pre-washing soiled laundry.

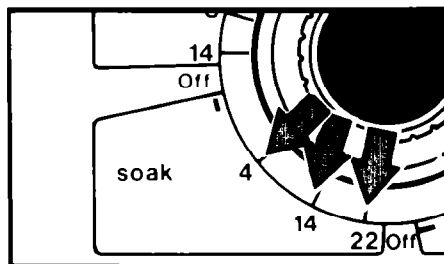

- Use enough detergent or pre-soak product for a single load.
- Push Control Knob in.
- Turn clockwise to point at a **number** in the SOAK Cycle.
- Pull Control Knob out.
- When the cycle is over, add detergent for the next selected wash cycle. **Important: See additional care information on page 7 of your "Laundry Guide."**
- Set the washer and start the next selected wash cycle.

To start the soak or pre-wash with agitation, the Cycle Control Knob must point to a number in the SOAK Cycle.

### Cleaning the lint filter

Water runs through the lint filter whenever the washer agitates. Check it often to make sure it's clean and is filtering at its best.

To remove it for cleaning, press the release and pull straight out. Instructions for cleaning are printed on the bottom of the filter.

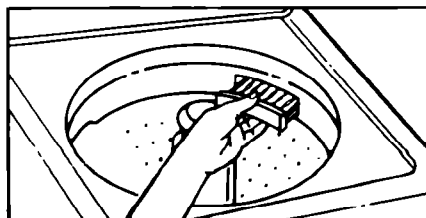

# Starting your dryer

Before starting your dryer, be sure laundry is sorted and loaded properly (see your "Laundry Guide"). **Be sure the door is tightly closed.**

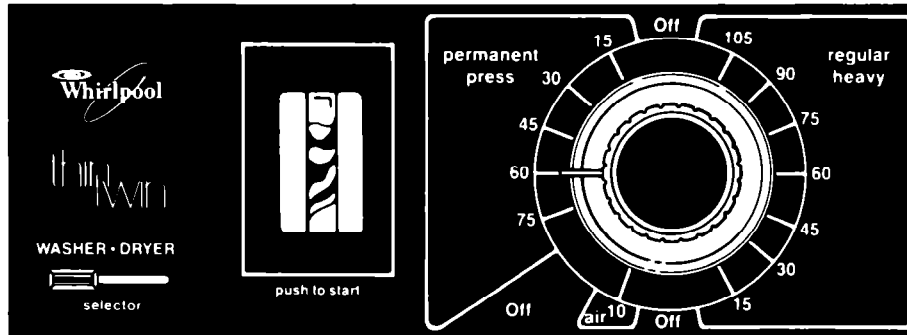

## 1. SELECTOR SWITCH



Move Selector Switch to DRYER position. Dryer will not operate when switch is in WASHER position.

## 2. CYCLE and TIME

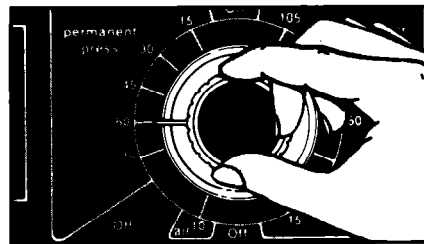

Turn the Control Knob either way to point to the time setting you want in the cycle you want.

## 3. START Button

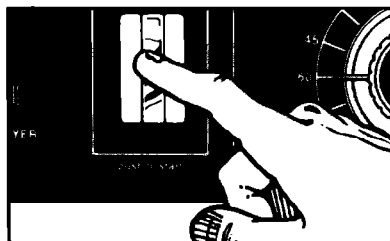

The dryer will start tumbling when you push the START Button.

## 4. To stop and restart the dryer

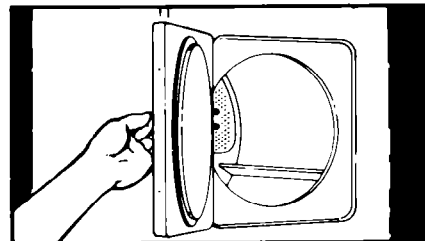

**To stop**, open the door (or turn the Control Knob to OFF).

**To restart**, close the door and push the START button.

The Cycle Control Knob should point to OFF when the dryer is not in use.

# Selecting a cycle

Dryer cycles are designed for the proper drying of different kinds of fabrics. This dryer has 3 cycles:

**REGULAR HEAVY** – The heat is off during the last 5 minutes of tumbling. The load is cooled down for more comfortable handling.

**PERMANENT PRESS** – The heat is off during the last 10 minutes of tumbling to help keep wrinkles from setting in. Clothing wrinkled from packing in suitcases or closets can be smoothed out by tumbling them in this cycle for about 20 minutes.

**AIR** – No heat. This cycle is useful when drying heat-sensitive items or when fluffing pillows and bedding or dusting sheers and curtains.

**Drying plastic or rubber items with heat may damage the items or be a FIRE HAZARD.**

TYPE OF LOAD	SUGGESTED CYCLE
<b>COTTONS</b>	
HEAVY – Bedspreads, mattress pads, quilts	REGULAR HEAVY
MEDIUM AND LIGHTWEIGHT – Shirts, dresses, sheets, diapers, towels, work clothes	REGULAR HEAVY
<b>PERMANENT PRESS</b>	
HEAVY – Work clothes, jackets, raincoats, etc.	PERMANENT PRESS
MEDIUMWEIGHT – Shirts, uniforms, dresses, slacks, etc.	PERMANENT PRESS
<b>KNITS</b>	
HEAVYWEIGHT – COTTONS, RAYONS, BLENDS – T-Shirts, slacks, polo shirts, etc.	PERMANENT PRESS
LIGHTWEIGHT – SYNTHETIC FIBERS (polyester, acrylic, etc.) AND BLENDS – Lingerie, blouses, dresses, etc.	PERMANENT PRESS
<b>DELICATELY CONSTRUCTED FABRICS –</b>	
Sheer Curtains (2 or 3 panels)	PERMANENT PRESS
<b>RUBBER, PLASTIC, HEAT SENSITIVE FABRICS</b>	
Pillows, bras, etc.	AIR
Plastic shower curtains, tablecloths	AIR
Rubber backed rugs	AIR
Olefin, polypropylene, sheer nylon	AIR

**Drying these and other heat-sensitive materials can damage them or be a FIRE HAZARD.**

## Drying tips

### Drying times

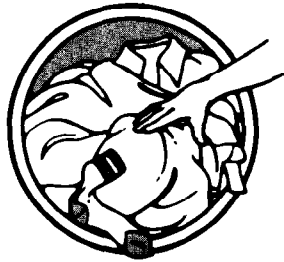

Drying times will vary depending on:

- amount of moisture in the clothes.
- type and weight of the fabric.
- size of the load.
- room temperature around the dryer.
- temperature of the wash rinse water.
- amount of lint in the lint screen.

**NOTE: 120 volt dryers have longer drying times.**

See page 19 in your "Laundry Guide" for more information.

**DO NOT OVERDRY.** Overdrying can cause shrinkage, static cling, and can damage some fabrics.

### Mixed loads

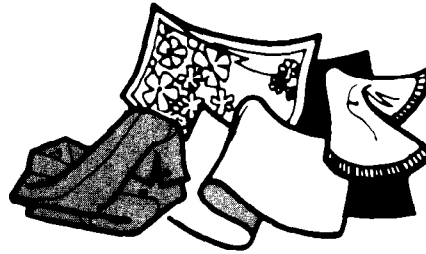

When drying a load with different kinds and weights of fabrics, use the cycle suggested for the lightest fabrics. When the dryer stops, remove dry items and reset the control.

To help reduce wrinkling, take the load from the dryer as soon as tumbling stops. This is very important for permanent press, knits and other synthetic fabrics.

# Lint screen

**Clean the lint screen before each load.** A screen blocked by lint can increase drying time and may be a FIRE HAZARD.

The lint screen is inside the dryer drum, on the back wall. **Pull straight out.**

1. Use the finger holes to pull the lint screen straight out.

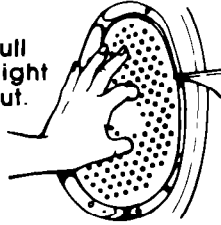

**WARNING: DO NOT** run the dryer with the lint screen loose, damaged or missing. Doing so can cause overheating, can damage fabrics and can be a **FIRE HAZARD.**

2. Lightly squeeze the body, as shown, while pulling the cover off.

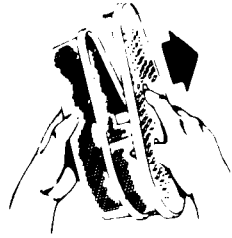

**Squeeze body; pull cover off.**

3. Roll lint off the screen with your fingers. **DO NOT rinse or wash the screen. Wet lint is hard to remove.**
4. Replace the cover on the body of the lint screen.
5. Push the lint screen straight back in until it clicks into place.

# Lint removal

Lint can gather inside the dryer and create a fire hazard. **This lint should be removed every 2 to 3 years, or more often, depending on dryer usage.**

**Cleaning should be done only by a qualified service person.**

1. Remove back panel from dryer.
2. Avoid touching thermostats, wires, terminals and heater box.
3. Remove lint from shaded area – see art – with a soft brush or vacuum cleaner.
4. Replace back panel. Reconnect, exhaust duct, etc. Level the washer / dryer.



- **Avoid electrical shock hazard – unplug power supply cord or turn off electrical power.**
- **Avoid injury or damage – do not put hands inside cabinet.**
- **Metal edges may be sharp.**
- **Make sure dryer is cool.**

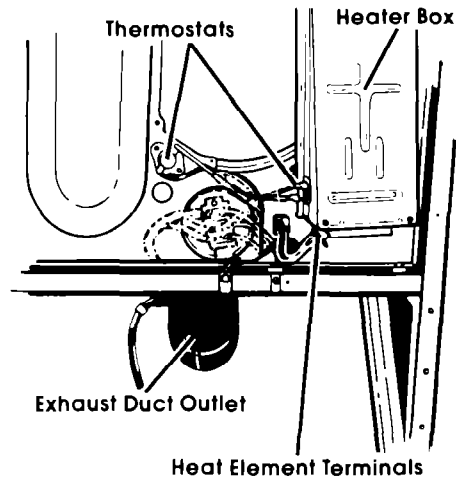

# Caring for your washer • dryer

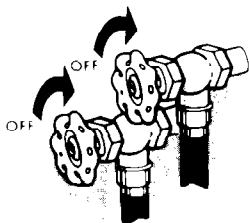

**When not washing,** keep both water faucets turned off. This takes the pressure off the water inlet valve and hoses.

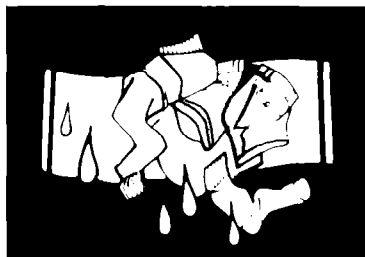

**Never use the washer to...**

- soak for more than 2 hours
- soak with chlorine bleach.
- soak with vinegar or other acids.
- soak or store urine soaked clothes.

**Never leave or store** wet, damp or dry laundry in your washer or dryer.

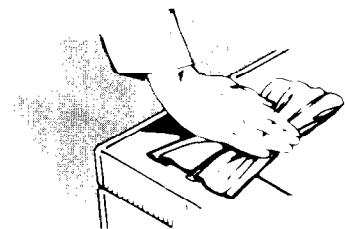

**After washing,** use a soft dry cloth to wipe the outside and inside dry. Leave washer lid up until the basket is dry. **Wipe up all spills.** Spills allowed to remain may dull or damage the finish.

**Remove loose and sharp objects** from pockets and cuffs before washing or drying – pins, buckles, etc. **Close metal zippers.**

**Sharp or heavy objects** should never be put on or in the washer or dryer. Check pockets for bolts, nuts, etc.

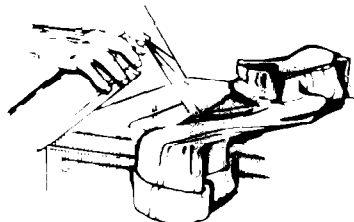

**Some pretreatment products** can damage dials, consoles and finish. Do not use these products on or near your washer or dryer.

## Cleaning dryer interior

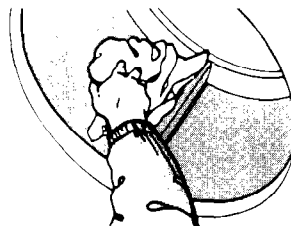

**Before cleaning interior, unplug power supply cord or turn off electrical power to avoid electrical shock hazard.**

Garments which contain unstable dyes, such as denim blue jeans or brightly colored cotton items, may discolor the dryer interior. If the interior is discolored, clean with one of the following methods to avoid staining later load items.

### **Powdered laundry detergent and very warm water**

Make a paste with detergent and very warm water. Apply paste to a soft cloth and scrub area until all excess dye is removed. Wipe thoroughly with a damp cloth. Tumble a load of rags. **-OR-**

### **Liquid spray household cleaner**

Spray on stained area. Rub with a cloth until all excess dye is removed. Tumble a load of rags.

## Vacation care

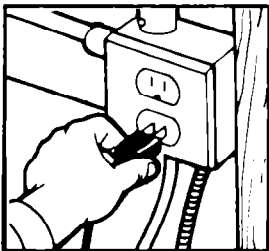

1. Turn off both water faucets to take pressure off inlet valves and hoses.
2. Unplug power supply cord or turn off electrical power supply.
3. Clean lint screen and lint filter.

## Winterizing

Install and store your washer / dryer where it won't freeze. Because some water stays in the washer, freezing can damage it. If your washer / dryer is stored **or moved** during freezing weather, winterize it.

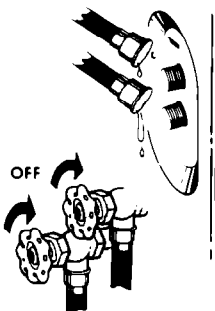

1. Shut off both water faucets. Disconnect and drain water inlet hoses.



2. Put a quart of automobile-type antifreeze in the basket.

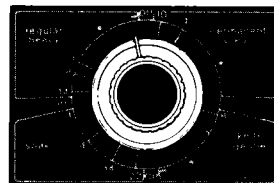

3. Run washer on a drain and spin setting (see page 10) for about 30 seconds to mix antifreeze and water.

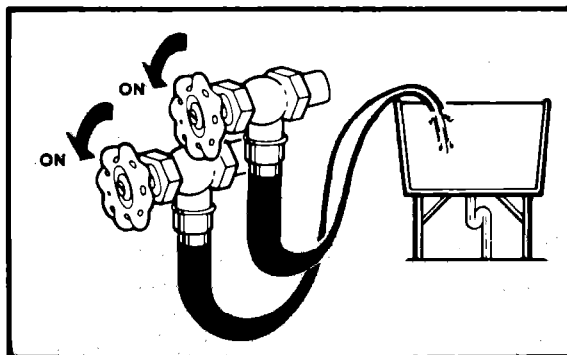

### To use washer again:

1. Flush water pipes and hoses.
2. Reconnect water inlet hoses.
3. Turn on both water faucets.

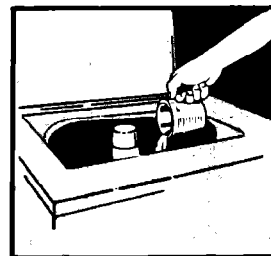

4. To clean out anti-freeze, run washer through a complete cycle with a cup of detergent.



## If you need service or assistance, we suggest you follow these four steps:

### 1. Before calling for assistance...



Performance problems often result from little things you can find and fix yourself without tools of any kind.

#### If your washer does not fill:

- Is the power supply cord plugged into a live circuit with the proper voltage?
- Are both water faucets open?
- Have you checked your home's main fuses or circuit breaker box?
- Are the water supply hoses kinked?
- Is the Cycle Control Knob set and pulled out?
- Is Selector Switch set in the WASHER position?

#### If your washer does not spin:

- Is the lid closed?
- Is the power supply cord plugged into a live circuit with the proper voltage?

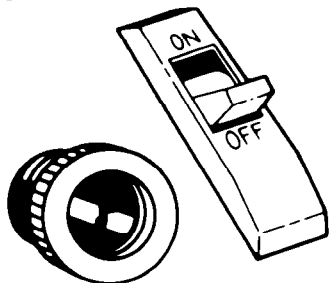

- Have you checked your home's main fuses or circuit breaker box?

#### If Your washer drains at the wrong time:

- The drain hose should be at least 28 inches above the floor and secured.
- The drain hose should not fit tightly in the drain pipe.
- Make sure that the Cycle Control Knob is pointing to a number in the cycle.

#### Make sure the drain hose is higher than the water level in the washer. If it isn't...

- The washer may seem to be draining during wash and rinse cycles.
- Water can siphon out. (See "Installation Instructions.")

#### If your washer stops during the permanent press cycle:

- Remember, the washer will stop for about 2 minutes after the partial drain during the cool-down period in this cycle.

#### If your dryer does not run or heat:

- Is the power supply cord plugged into a live circuit with the proper voltage?
- Is the door closed tightly?
- Did you push START?
- Have you checked your home's main fuses or circuit breaker box?
- The AIR setting is without heat.
- The last minutes of heat settings are without heat. See page 12.
- Is Selector Switch set in the DRYER position?

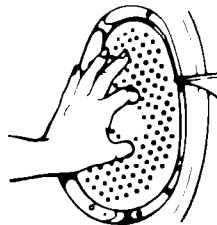

#### If drying times seem too long:

- Is the lint screen clean?
- Is the room cold?
- See page 13 of this book and page 19 of your "Laundry Guide."

## 2. If you need assistance\*...

Call Whirlpool COOL-LINE® service assistance telephone number. Dial free from:

**Continental U.S. . . (800) 253-1301**  
**Michigan . . . . . (800) 632-2243**  
**Alaska & Hawaii (800) 253-1124**

and talk with one of our trained Consultants. The Consultant can instruct you in how to obtain satisfactory operation from your appliance or, if service is necessary, recommend a qualified service company in your area.

## 3. If you need service\*...



Whirlpool has a nationwide network of franchised TECH-CARE® Service Companies. TECH-CARE service technicians are trained to fulfill the product warranty and provide after-warranty service, anywhere in the United States. To locate TECH-CARE service in your area, call our COOL-LINE service assistance telephone number (see Step 2) or look in your telephone directory Yellow Pages under:

APPLIANCES - HOUSEHOLD - MAJOR - SERVICE & REPAIR	OR	ELECTRICAL APPLIANCES - MAJOR - REPAIRING & PARTS
WHIRLPOOL APPLIANCES FRANCHISED TECH-CARE SERVICE		WHIRLPOOL APPLIANCES FRANCHISED TECH-CARE SERVICE
<i>SERVICE COMPANIES</i> XYZ SERVICE CO 123 Maple . . . . . 999-9999		<i>SERVICE COMPANIES</i> XYZ SERVICE CO 123 Maple . . . . . 999-9999
OR		
WASHING MACHINES, DRYERS & IRONERS - SERVICING		
WHIRLPOOL APPLIANCES FRANCHISED TECH-CARE SERVICE		
<i>SERVICE COMPANIES</i> XYZ SERVICE CO 123 Maple . . . . . 999-9999		

## 4. If you have a problem\*...

Call our COOL-LINE service assistance telephone number (see Step 2) and talk with one of our Consultants, or if you prefer, write to:

Mr. Stephen E. Upton  
Senior Vice President  
Whirlpool Corporation  
Administrative Center  
2000 US-33, North  
Benton Harbor, MI 49022

\*If you must call or write, please provide: model number, serial number, date of purchase, and a complete description of the problem. This information is needed in order to better respond to your request for assistance.



FSP is a registered trademark of Whirlpool Corporation for quality parts. Look for this symbol of quality whenever you need a replacement part for your Whirlpool appliance. FSP replacement parts will fit right and work right, because they are made to the same exacting specifications used to build every new Whirlpool appliance.





Making your world a little easier.

Part No. 693017  
©1985 Whirlpool Corporation

Printed in U.S.A.

---

omatic Washers, Clothes Dryers, Freezers, Refrigerator-Freezers, Ice Makers, Dishwashers, Built-In Ovens and Surface Units, Ranges, Mi

